

Ersteller:	Robert Miehle	Projekt:	Umkehrosroseanlagensteuerung	Kunde:	
Geprüft:		Anlage:	UOA mini	Zeichen-Nr.:	
Erstellt/Geändert:	01.04.05 15:36/03.03.06 21:36	Datei:	UOA-Steuerung-neu.lsc	Seite:	1 / 3

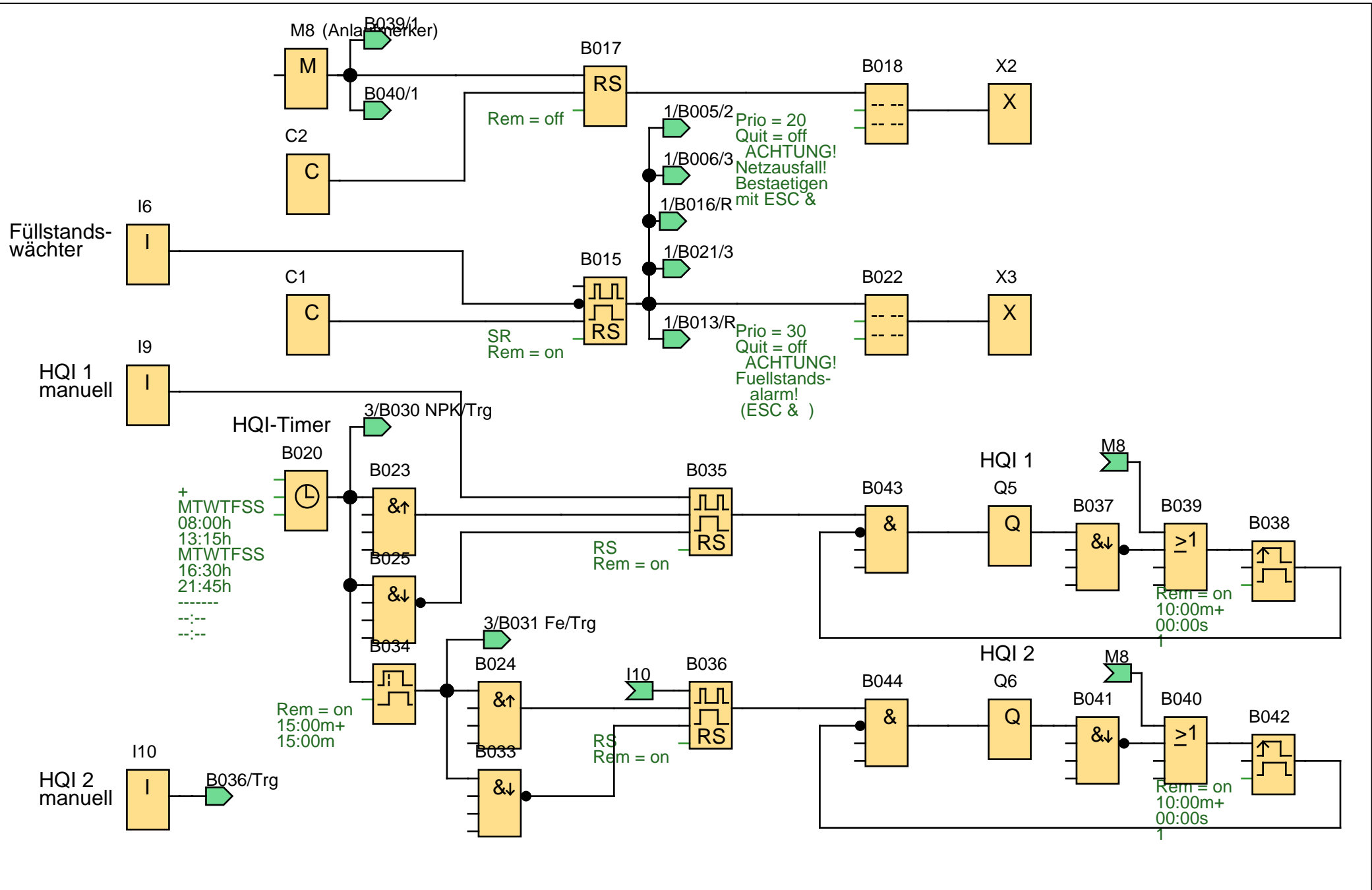

Ersteller:	Robert Miehle	Projekt:	Umkehrmoseanlagensteuerung	Kunde:	
Geprüft:		Anlage:	UOA mini	Zeichen-Nr.:	
Erstellt/Geändert:	01.04.05 15:36/03.03.06 21:36	Datei:	UOA-Steuerung-neu.lsc	Seite:	2 / 3

NPK
manuell

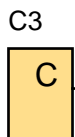

RS
Rem = off

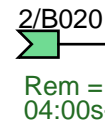
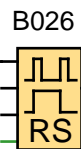

Rem = off
04:00s+

B030 NPK

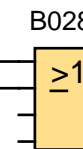
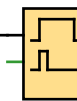

Dosierpumpe
NPK

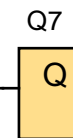

Spurenelemente
manuell

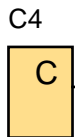

RS
Rem = off

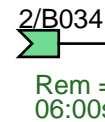
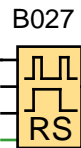

Rem = off
06:00s+

B031 Fe

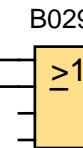
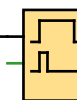

Dosierpumpe
Spurenelemente

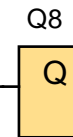

Ersteller:	Robert Miehle	Projekt:	Umkehrosroseanlagensteuerung	Kunde:	
Geprüft:		Anlage:	UOA mini	Zeichen-Nr.:	
Erstellt/Geändert:	01.04.05 15:36/03.03.06 21:36	Datei:	UOA-Steuerung-neu.lsc	Seite:	3 / 3